

P/N: FAT74021

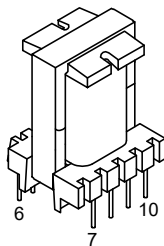

Outline Dimensions (Unit:mm)

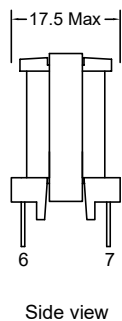
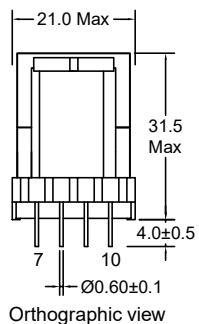

Stereogram

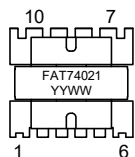

Top view

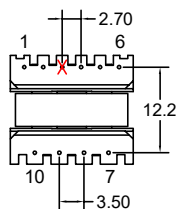

Bottom view

REMARK:

1. Fixed Core With 2Ts Tape.
2. Remove pin3. Cut pin5 2/3.
3. Product vacuum impregnation.

Electrical Schematic

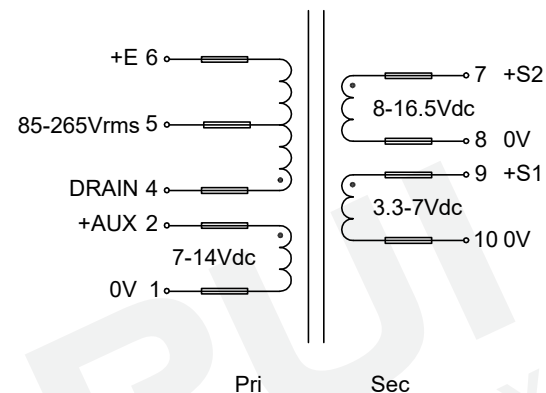

"." Dotted terminal
— White teflon tube

General Properties:

- Operating Temperature: -40°C to +105°C.
- Storage Temperature: -25°C to +85°C.
- Insulation Class: B.

Wave Soldering

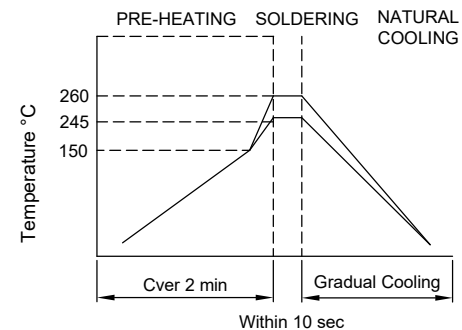

Note:

1. Never Contact the ceramic with the iron tip:
2. 1.0mm tip diameter(max).

Electrical Characteristics

- Inductance : L4-6= 0.90mH ±10%, at 1KHz, 0.3V.
- D.C. Resistance : 1-2= 1.050 ohms Max.
- 4-6= 0.700 ohms Max.
- 7-8= 0.065 ohms Max.
- 9-10= 0.020 ohms Max.
- Turns Ratio : Pri:Aux:S1:S2=108:12:6:14±2%, at 20KHz, 1V.
- Hipot : Pri-Sec : 4000VAC/5mA/2S.
- Pri&Sec-Core : 1500VAC/5mA/2S.
- Pri-Aux : 1500VAC/5mA/2S.

				Tianchang Fuan Electronic Co Ltd		Make: Qiumei.Liu	DRAWING TITLE	Customer P/N:
				www.fuantronics.net	Tolerances unless otherwise specified:	Checked: Beson. zhan	EL19 FLYBACK TRANSFORMER	Document/Rev: 00
				TEL: +86-550-7814888	(.X)±0.50 (XX)±0.25	Approved: Anson. zhan	Material Number: A2174021S000	Specification Sheet: 1 of 2
REV	DESCRIPTION	APPD	DATE	FAX: +86-550-7831133	Unit of measurement: mm			Date of Recognition: Aug./04/2020

P/N: FAT74021



List of UL Certificate:

No.	Part Name	Mat'l Description	Supplier	UL Number
1	Bobbin	PY-1922/PM9630/FAY01041	Sumitomo Bakelite Co Ltd	E41429
2	Copper wire	2UEW-F/155C	Dong Guan YiDa Industrial Co Ltd	E344055
		2UEW-F/155C	Elektrisola Hangzhou Co Ltd	E258243
3	Core	EE19/13/5 HPP4	Anhui Hualin Magnetic Technology Go Ltd	N/A
		EE19/13/5 GP4	Su Zhou Guanda Magnet Co Ltd	N/A
4	Tape	JY25-A(b)/130C(Faint Yellow)	Jingjiang Jingyi Adhesive Product Co Ltd	E246950
		CT (b)(g)/130C(Faint Yellow)	JingJiang Yahua Pressure Sensitive Glue Co Ltd	E165111
5	Margin tape	WF310(a)/130C	Jingjiang Jingyi Adhesive Product Co Ltd	E246950
		WF* (c)(h)/130C	JingJiang Yahua Pressure Sensitive Glue Co Ltd	E165111
6	Tube	CB-TT-L/200°C	ChangYuan Electronics Group Co Ltd	E180908
		CB-TFL/200°C	Dongguan City Changjie Metals & Plastic Products Co Ltd	E338209
7	Varnish	T-4260(a)/MW80-C	SuZhou TaiHu Electric Advanced Material Co Ltd	E228349

Label:

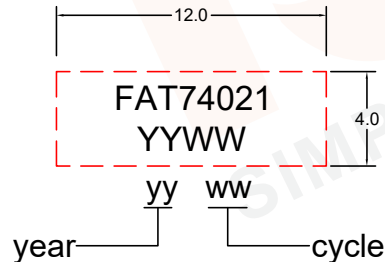

Remark:

- 1.Use Laser printing;
- 2.Clear writing and legibility, not easy to erase;
- 3.Border here means size range, not be printed;
- 4.Font:Arial;Height:1.20mm.

				Tianchang Fuan Electronic Co Ltd www.fuantronics.net TEL: +86-550-7814888 FAX: +86-550-7831133	Tolerances unless otherwise specified: (.X)±0.50 (XX)±0.25 Unit of measurement: mm	Make: Qiumei.Liu Checked: Beson. zhan Approved: Anson. zhan	DRAWING TITLE EL19 FLYBACK TRANSFORMER Material Number: A2174021S000	Customer P/N: Document/Rev: 00 Specification Sheet: 2 of 2 Date of Recognition: Aug./04/2020
REV	DESCRIPTION	APPD	DATE					