

**P3**    **T12.7\*7.14\*6.35**    **C/P**  
**Material**    **Core Size**    **Coating**  
 材质    品名    涂装

C=Epoxy. P=Parylene.

## Ferrite core

### Dimensions: (UNIT:mm)

Dimensions(mm)			
Epoxy Coating Dimensions(mm)			
ΦD1	ΦD2	H	Wt(g/set)
12.7±0.40	7.14±0.30	6.35±0.30	2.70
13.70 max	6.24 min	7.25 max	

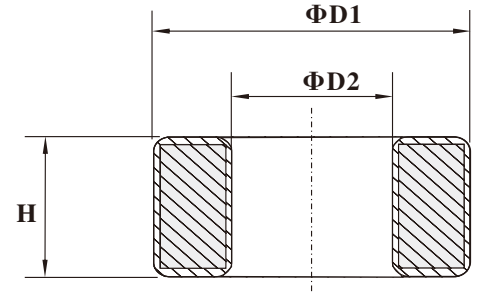
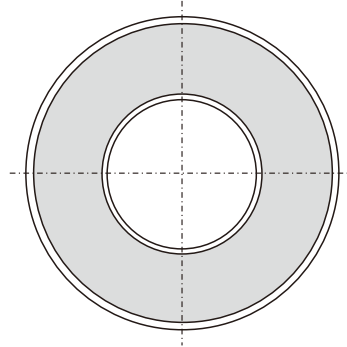

### Test Conditions

AL: F=10.0KHz U=0.3V N=10Ts

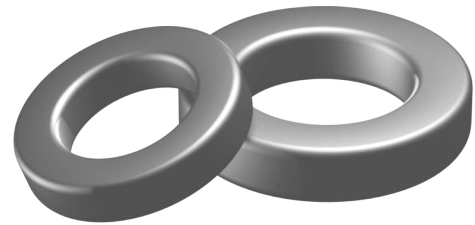

### Effective parameter

	Ve(mm3)	Ae(mm2)	Le(mm)
	507	17.2	29.5

### Coating

The core are coated with epoxy, flame retardant in accordance with "UL 94V-0" file number E228348. The colour is green.

### Ring core data

GRADE	AL(nH)	μi	TYPE NUMBER
P3	1800±25%	≈2300	T12.7/7.14/6.35/P3
H5K	3700±25%	≈5000	T12.7/7.14/6.35/H5K
H7K	5100±25%	≈7000	T12.7/7.14/6.35/H7K
H10K	7300±30%	≈10000	T12.7/7.14/6.35/H10K

### Note:

- 1: Document is the property of FUAN Inc & is not allowed to be duplicated without authorization
- 2: RoHS compliant.

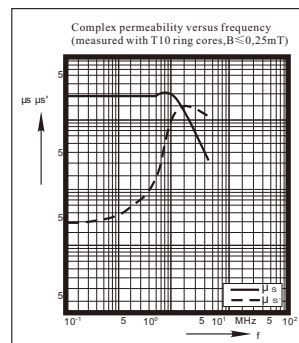

P3

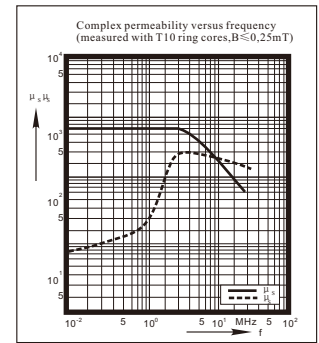

H5K

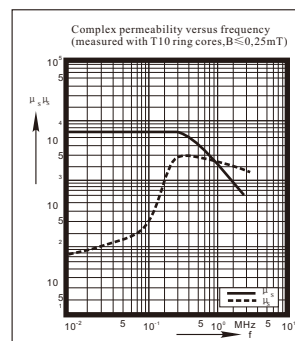

H7K

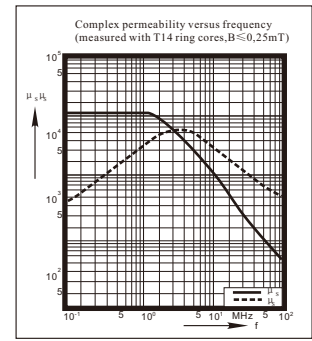

H10K