

**P3**      **T49\*31.8\*16**      **C/P**  
**Material**    **Core Size**    **Coating**  
 材质            品名            涂装

C=Epoxy. P=Parylene.

## Ferrite core

### Dimensions: (UNIT:mm)

Dimensions(mm)			
Epoxy Coating Dimensions(mm)			
ΦD1	ΦD2	H	Wt(g/set)
49.0±0.60	31.8±0.60	16.0 ±0.60	74.6
50.4max	30.4min	15.00max	

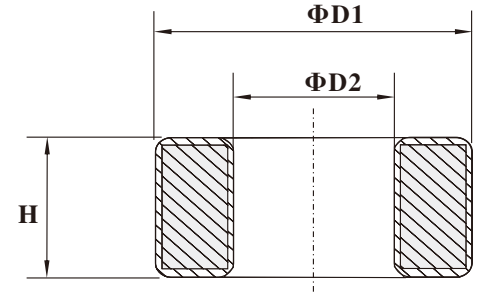
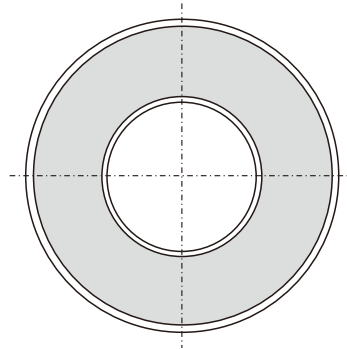

### Test Conditions

AL: F=10.0KHz U=0.3V N=10Ts

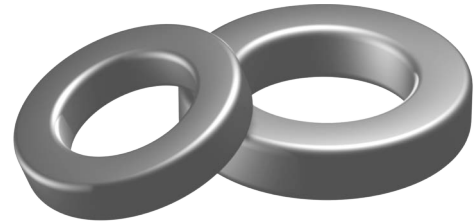

### Effective parameter

	Ve(mm <sup>3</sup> )	Ae(mm <sup>2</sup> )	Le(mm)
	16622	135	123

### Coating

The core are coated with epoxy, flame retardant in accordance with "UL 94V-0" file number E228348. The colour is green.

### Ring core data

GRADE	AL(nH)	μi	TYPE NUMBER
P3	3800±25%	≈2300	T49/31.8/16/P3
H5K	7600±25%	≈5000	T49/31.8/16/H5K
H7K	9300±25%	≈7000	T49/31.8/16/H7K
H10K	14800±30%	≈10000	T49/31.8/16/H10K

### Note:

- 1: Document is the property of FUAN Inc & is not allowed to be duplicated without authorization
- 2: RoHS compliant.

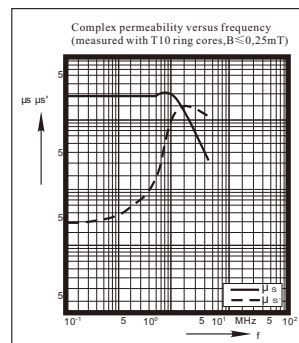

P3

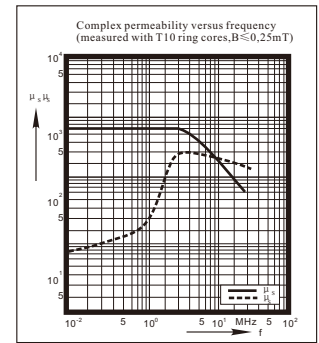

H5K

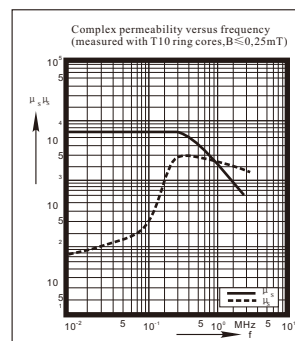

H7K

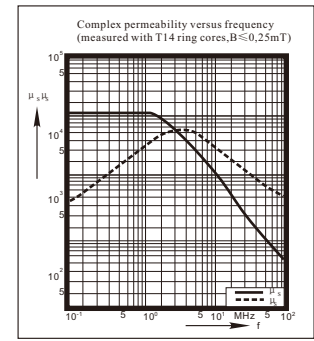

H10K