



PAIRUI

Http:fuantronics.com

P3 **T6*3*3** **HP**
Material **Core Size** **Coating**
 材质 品名 涂装

HP:Parylene Coating of Ja;pgem-Free

Dimensions: (UNIT:mm)

Dimensions(mm)			Wt(g/set)
Parylene Coating Dimensions(mm)			
ΦD1	ΦD2	H	0.32
6.0±0.3	3.0±0.3	3.0±0.2	
6.0±0.3	3.0±0.3	3.0±0.2	

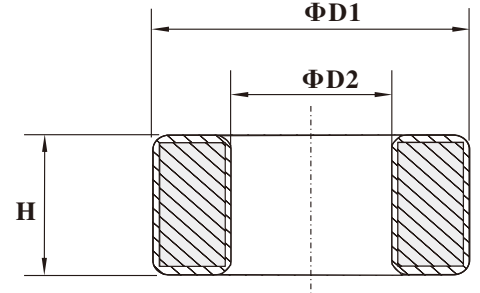
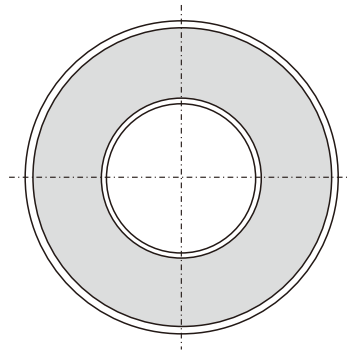

Test Conditions

AL: F=10.0KHz U=0.3V N=10Ts

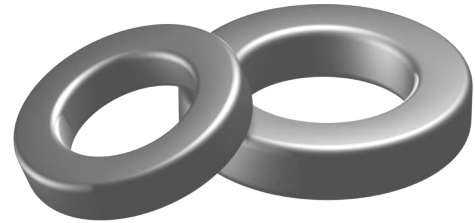

Effective parameter

	Ve(mm3)	Ae(mm2)	Le(mm)
	84.6	6.0	14.1

Coating

The core are coated with epoxy, flame retardant in accordance with "UL 94V-0" file number E228348. The colour is green.

Ring core data

GRADE	AL(nH)	μi	TYPE NUMBER
P3	1000±25%	≈2300	T6/3/3/P3
H5K	2800±25%	≈5000	T6/3/3/H5K
H7K	3900±25%	≈7000	T6/3/3/H7K
H10K	5600±30%	≈10000	T6/3/3/H10K

Note:

- 1: Document is the property of FUAN Inc & is not allowed to be duplicated without authorization
- 2: RoHS compliant.

Ferrite core

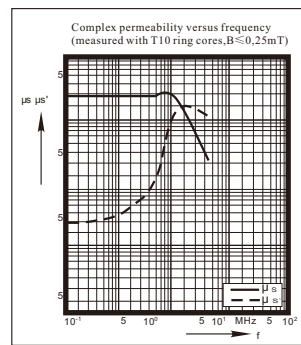

P3

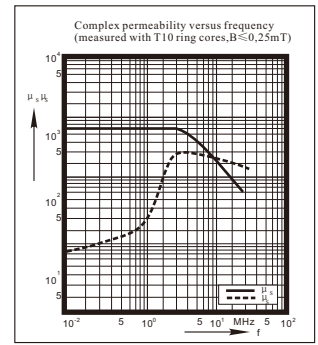

H5K

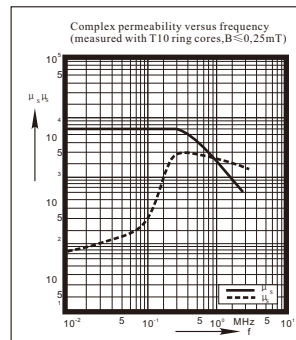

H7K

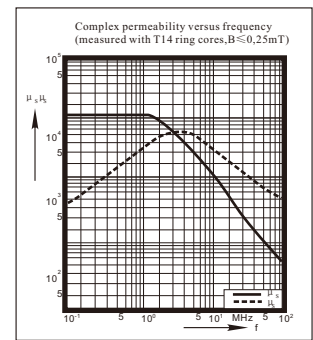

H10K