

Outline Dimensions(Unit:mm)

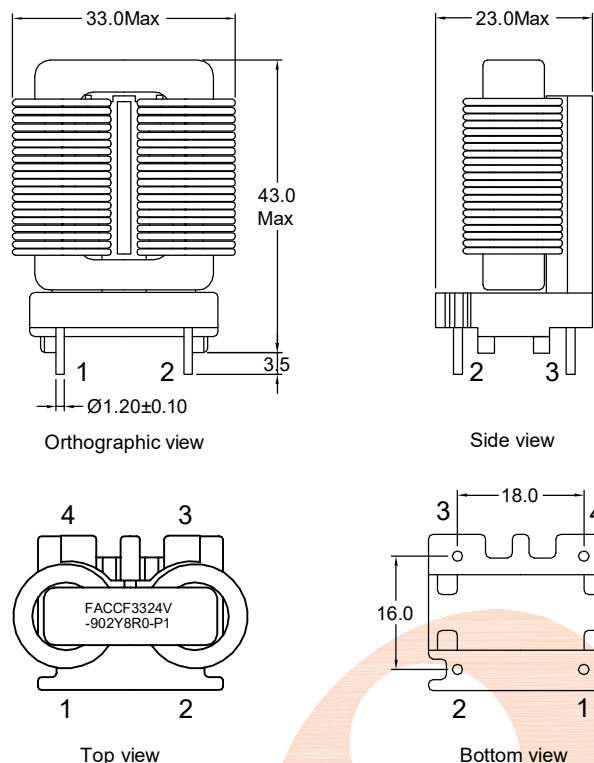

Electronical Schematic

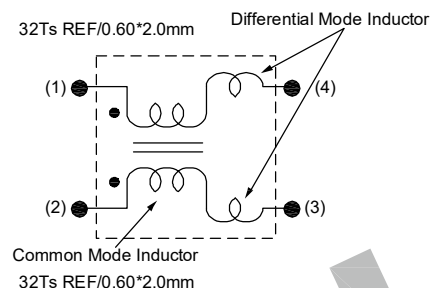

Simulation test curve:

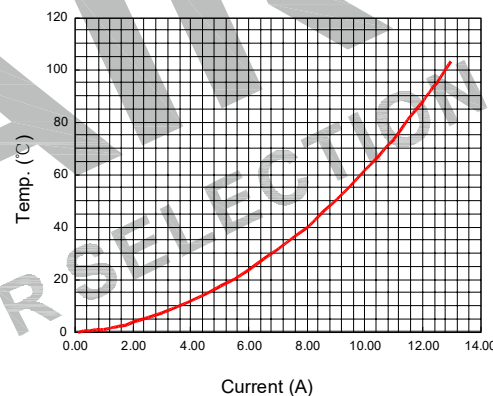

Electrical Characteristics(at 25°C)

Inductance : 9.0mH Min,at 1KHz,0.25V.
 Lstray: Lkg=64uH typ,at 1KHz,0.25V.
 Inductance balance : L1-L2= 300uH Max,at 1KHz,0.25V.
 D.C.Resistance: 24.0 mohms Max.
 Rated current: 8.0Amps.
 Turns Ratio : 1:1±0Ts,at 20KHz,1V.
 Hipot : Pri-Sec : 1500VAC/5mA/2Second.

List of UL Certificate:

Part Name	Mat'l Description	Supplier	UL Number
Bobbin	SQ3324/T375HF	Chang Chun Plastics Co Ltd	E59481
Copper wire	SFT-UEW-H	Ningbo Jintian New Material Co Ltd	E227047
Core	SQ3324-H12K	Shangdong HenRui Magnet Technology Co.,Ltd	N/A
Epoxy or Varnish	YZ-HC-1401C T4260LZ	YouZhi Electronic(DongGuan)Co.,Ltd Suzhou Taihu Electric Advanced Material Co., Ltd	N/A E228349

***Weight:Approx 51.5g.

Tianchang Fuan Electronic Co Ltd
 www.fuantronics.net
 TEL: +86-550-7814888
 FAX: +86-550-7831133



Tolerances unless otherwise specified:
 (.X)±0.50 (.XX)±0.25
 Unit of measurement: mm

Make: *Jinle*
 Checked: *BenSon*
 Approved: *AnSan*

DRAWING TITLE
 CCF3324V Current-compensated
 frame core double chokes
 Material Number:

Customer P/N:
 Document/Rev: 2207433/00
 Specification Sheet: 1 of 1
 Date of Recognition: July./23/2022

REV	DESCRIPTION	APPD	DATE